

Airflow Temperature Humidity Adapter

INSTRUCTION MANUAL

ENGLISH



REQUIRES Compatible mobile device and the **FREE** downloadable App

1-800-547-5740

www.ueitest.com • email: info@ueitest.com

FCC INFORMATION

NOTE: This device complies with Part 15 of the FCC Rules. Operation is subject to the following two conditions: (1) this device may not cause harmful interference, and (2) this device must accept any interference received, including interference that may cause undesired operations.

INFORMATION TO THE USER

This equipment has been tested and found to comply with the limits for a Class B digital device, pursuant to part 15 of the FCC Rules. These limits are designed to provide reasonable protection against harmful interference in a residential installation. This equipment generates, uses and can radiate radio frequency energy and, if not installed and used in accordance with the instructions, may cause harmful interference to radio communications. However, there is no guarantee that interference will not occur in a particular installation. If this equipment does cause harmful interference to radio or television reception, which can be determined by turning the equipment off and on, the user is encouraged to try to correct the interference by one or more of the following measures:

- Reorient or relocate the receiving antenna.
- Increase the separation between the equipment and receiver.
- Connect the equipment into an outlet on a circuit different from that to which the receiver is connected.
- Consult the dealer or an experienced radio/TV technician for help.

WARNING : Any changes or modifications not expressly approved by the manufacturer could void the user's authority to operate the equipment.

DISPOSAL



CAUTION: This symbol indicates that equipment and its accessories shall be subject to separate collection and correct disposal.

CLEANING

Periodically clean your adapters' case using a damp cloth. **DO NOT** use abrasive, flammable liquids, cleaning solvents, or strong detergents as they may damage the finish, impair safety, or affect the reliability of the structural components.

IMPORTANT SAFETY WARNINGS

⚠ WARNING : Read entire Safety Notes section regarding potential hazard and proper instructions before using this meter. In this manual the word "WARNING" is used to indicate conditions or actions that may pose physical hazards to the user. The word "CAUTION" is used to indicate conditions or actions that may damage this instrument.















FEATURES

- iOS® or Android™ compatibility
- Free App
- Extension screw input for extending into air flow
- Sliding cover

GENERAL SPECIFICATIONS

- **Temperature Range:** 5° ~ 122°F (-15° ~ 50°C)
- **Relative Humidity:** 0.1% RH ~ 99.9% RH
- **Operating Temperature:** 5° ~ 122°F (-15° ~ 50°C)
- **Storage Temperature:** 5° ~ 122°F (-15° ~ 50°C)
- **Dimensions:** 5.06" X 1.95" X 0.93"
- **Item Weight:** 2.8 oz
- **Battery Type:** CR2032 X 2
- **Temperature Accuracy:** ± 1.0°F (± 0.6°C)
- **Power Consumption:** <8 mA
- **App Compatibility:** Bluetooth® 4.0 and newer enabled devices
iOS® 10 and newer
Android™ 6.0 and newer

SYMBOLS

	Velocity Flow		Toolbox
	Dry Bulb		Relative Humidity
	Wet Bulb		Dew Point
	Home		Points Average
	Units		Support
	DTHA2		Round Duct
	Rectangle Duct		Time Average

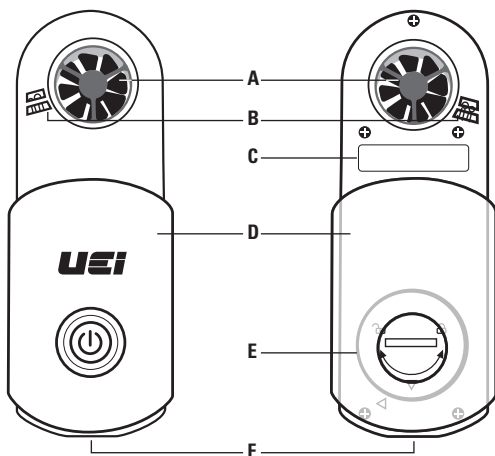

DTHA2 OVERVIEW



- A. Airflow Sensor Input**
- B. Humidity/Temperature Sensor Input**
- C. Serial Number**
- D. Sliding Cover**
- E. Battery Cover**
- F. Extension Screw Input**

OVERVIEW

Power

- **Short Press:** Press & hold Power  Button 1-2 seconds to turn on meter with 5 minute Auto Off function.
 - Green LED: power on
 - Red LED: battery is low
- **Long Press:** Press & hold Power  Button for 3 seconds to turn on and disable Auto Off function.
 - Blinking Green LED every 5 seconds, power on
 - Blinking red LED battery is low
- **To turn meter off:** Press & hold Power  Button for 5 seconds.

BATTERY REPLACEMENT

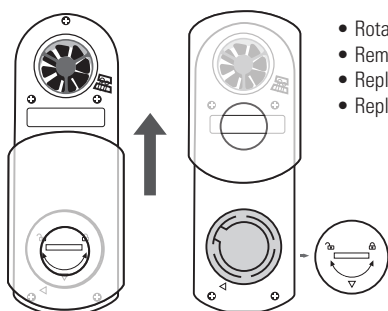

- Rotate cover till arrows are lined up
- Remove cover
- Replace battery with 2 (CR2032) batteries
- Replace cover

NOTE: The DTHA2 will disconnect from the device when battery levels are too low to display correct readings.

TROUBLESHOOTING

PROBLEM	SOLUTION
The app will not connect with DTHA2	Check batteries in DTHA2
The app suddenly errors out, loses connection and is unable to reconnect	Check batteries in DTHA2

STORAGE

Remove the batteries when instrument is not in use for a prolonged period of time. Do not expose to high temperatures/too low temperatures or humidity. After a period of storage in extreme conditions exceeding the limits mentioned in the General Specifications section, allow the instrument to return to normal operating conditions before using it.

WARRANTY

The DTHA2 is warranted to be free from defects in materials and workmanship for a period of one year from the date of purchase. If within the warranty period your instrument should become inoperative from such defects, the unit will be repaired or replaced at UEi's option. This warranty covers normal use and does not cover damage which occurs in shipment or failure which results from alteration, tampering, accident, misuse, abuse, neglect or improper maintenance. Batteries and consequential damage resulting from failed batteries are not covered by warranty.

Any implied warranties, including but not limited to implied warranties of merchantability and fitness for a particular purpose, are limited to the express warranty. UEi shall not be liable for loss of use of the instrument or other incidental or consequential damages, expenses, or economic loss, or for any claim or claims for such damage, expenses or economic loss.

Warranty only covers hardware and does not extend to software applications.

A purchase receipt or other proof of original purchase date will be required before warranty repairs will be rendered. Instruments out of warranty will be repaired (when repairable) for a service charge

For more information on warranty and service, contact:

www.ueitest.com • Email: info@ueitest.com
1-800-547-5740

This warranty gives you specific legal rights. You may also have other rights, which vary from state to state.

